

# ➤ Instructions

Thule Motion 3  
639xxx

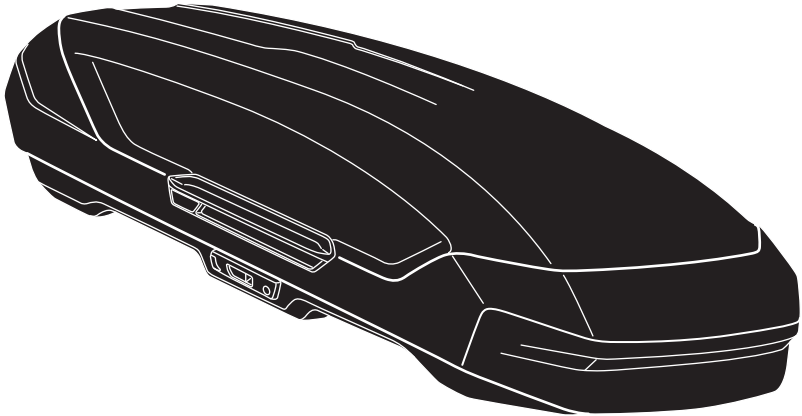

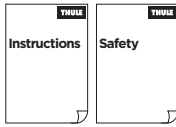



**EN**

**ROOF BOX FOR ROOF-MOUNTED RACKS**

FAILURE TO COMPLY WITH THE MANUFACTURER'S INSTRUCTIONS CAN LEAD TO SERIOUS INJURY OR DEATH.

**IMPORTANT** - READ CAREFULLY AND KEEP FOR FUTURE REFERENCE.

 **WARNING** INDICATES A HAZARDOUS SITUATION WHICH, IF NOT AVOIDED, COULD RESULT IN DEATH OR SERIOUS INJURY.

 **NOTE** INDICATES ADDITIONAL INFORMATION THAT IS USEFUL FOR TROUBLE-FREE AND OPTIMAL USE OF THE PRODUCT

**FR**

**COFFRE POUR BARRES DE TOIT**

LE NON-RESPECT DES INSTRUCTIONS DU FABRICANT PEUT ENTRAÎNER DES BLESSURES GRAVES OU LA MORT.

**IMPORTANT** - LISEZ ATTENTIVEMENT CES INSTRUCTIONS ET CONSERVEZ-LES POUR RÉFÉRENCE FUTURE.

 **AVERTISSEMENT** INDIQUE UNE SITUATION POTENTIELLEMENT DANGEREUSE QUI, SI ELLE N'EST PAS ÉVITÉE, POURRAIT PROVOQUER DES BLESSURES GRAVES, VOIR MORTELLES.

 **REMARQUE** INDIQUE COMMENT RÉPONDRE À UNE SITUATION DONNÉE U VOUS DONNENT DES CONSEILS SUR LE FONCTIONNEMENT DES OPTIONS DISPONIBLES.

**ES**

**COFRE PORTAEQUIPAJES PARA BARRAS DE TECHO**

EL INCUMPLIMIENTO DE LAS INSTRUCCIONES DEL FABRICANTE PUEDE PROVOCAR LESIONES GRAVES O LA MUERTE.

**IMPORTANTE** - LEA ATENTAMENTE Y CONSERVELO PARA FUTURAS CONSULTAS.

 **ADVERTENCIA** INDICA UNA SITUACIÓN DE PELIGRO QUE, SI NO SE EVITA, PODRÍA PROVOCAR LESIONES GRAVES O INCLUSO LA MUERTE.

 **NOTA** INDICA INFORMACIÓN ADICIONAL QUE ES ÚTIL PARA UN USO ÓPTIMO Y SIN PROBLEMAS DEL PRODUCTO.

**DE**

**DACHBOX FÜR DACHTRÄGER**

DIE NICHTEINHALTUNG DER ANWEISUNGEN DES HERSTELLERS KANN ZU SCHWEREN VERLETZUNGEN ODER ZUM TOD FÜHREN.

**WICHTIG** - LESEN SIE DIESE ANLEITUNG SORGFÄLTIG DURCH UND BEWAHREN SIE ZUM NACHSCHLAGEN AUF.

 **WARNUNG** WEIST AUF EINE GEFÄHRLICHE SITUATION HIN, DIE ZU SCHWERWIEGENDEN VERLETZUNGEN ODER ZUM TODE FÜHREN KANN, WENN SIE NICHT VERMIEDEN WIRD.

 **HINWEIS** KENNZEICHNET ZUSÄTZLICHE INFORMATIONEN, DIE FÜR EINE STÖRUNGSFREIE UND OPTIMALE NUTZUNG DES PRODUKTS HILFREICH SIND..

## DAKBOX VOOR DAKDRAGER

HET NIET OPVOLGEN VAN DE INSTRUCTIES VAN DE FABRIKANT KAN LEIDEN TOT ERNSTIG LETSEL OF DE DOOD.

**IBELANGRIJK** - ZORGVULDIG LEZEN EN BEWAREN VOOR TOEKOMSTIG GEBRUIK.

 **WAARSCHUWING** DUIDT OP EEN GEVAARLIJKE SITUATIE DIE, INDIEN DEZE NIET WORDT VERMEDEN, DE DOOD OF ERNSTIG LETSEL TOT GEVOLG KAN HEBBEN.

 **OPMERKING** GEEFT AANVULLENDE INFORMATIE AAN DIE NUTTIG IS VOOR EEN PROBLEEMLOOS EN OPTIMAAL GEBRUIK VAN HET PRODUCT.

CAIXA BAGAGEIRA PARA BARRAS DE TEJADILHO  
O NÃO CUMPRIMENTO DAS INSTRUÇÕES DO FABRICANTE PODE LEVAR A FERIMENTOS GRAVES OU À MORTE.

**IMPORTANTE** - LEIA COM ATENÇÃO E GUARDE PARA REFERÊNCIA FUTURA

 **ATENÇÃO** INDICA UMA SITUAÇÃO PERIGOSA QUE, SE NÃO FOR EVITADA, PODE RESULTAR EM MORTE OU FERIMENTOS GRAVES.

 **NOTA** INDICA INFORMAÇÕES ADICIONAIS QUE SÃO ÚTEIS PARA O USO IDEAL E SEM PROBLEMAS DO PRODUTO.

## BOX DA TETTO PER PORTAPACCHI DA INSTALLARE SUL TETTO

LA MANCATA OSSERVANZA DELLE ISTRUZIONI DEL PRODUTTORE PUÒ CAUSARE GRAVI LESIONI O MORTE.

**IMPORTANTE** - LEGGERE ATTENTAMENTE E CONSERVARE PER RIFERIMENTO FUTURO.

 **AVVERTENZA** INDICA UNA SITUAZIONE DI PERICOLO CHE, SE NON EVITATA, PUÒ CAUSARE MORTE O GRAVI LESIONI.

 **NOTA** INDICA INFORMAZIONI AGGIUNTIVE UTILI PER UN USO OTTIMALE E SENZA PROBLEMI DEL PRODOTTO.

## TAKBOX FÖR TAKMONTERADE RÄCKEN

OM TILLVERKARENS ANVISNINGAR INTE FÖLJS KAN DET LEDA TILL ALLVARLIG SKADA ELLER DÖDSFALL.

**VIKTIGT** - LÄS INSTRUKTIONERNA NOGA OCH SPARA DEM FÖR FRAMTIDA BRUK.

 **VARNING** INDIKERAR EN FARLIG SITUATION SOM, OM DEN INTE UNDVIKS, KAN RESULTERA I DÖDSFALL ELLER ALLVARLIGA SKADOR.

 **OBS!** INNEHÅLLER YTTERLIGARE INFORMATION SOM ÄR ANVÄNDBAR FÖR PROBLEMFRI OCH OPTIMAL ANVÄNDNING AV PRODUKTEN.

## TAGBOKS TIL TAGBØJLER

MANGLENDE OVERHOLDELSE AF PRO-  
DUCENTENS ANVISNINGER KAN FØRE TIL  
ALVORLIG PERSONSKADE ELLER DØD.

**VIGTIGT** - LÆS OMHYGGELIGT OG OPBEV-  
AR DEN TIL SENERE BRUG.



**ADVARSEL** ANGIVER EN FARLIG SITU-  
ATION, SOM, HVIS DEN IKKE UNDGÅS, KAN  
FØRE TIL DØD ELLER ALVORLIG PERSON-  
SKADE.

**i BEMÆRK** ANGIVER YDERLIGERE OPLYS-  
NINGER, DER ER NYTTIGE FOR PROBLEM-  
FRI OG OPTIMAL BRUG AF PRODUKTET.

KATOLLE ASENNETTAVIIN TELINEISIIN  
SOPIVA KULJETUSLAATIKKO

VALMISTAJAN OHJEIDEN NOUDATTAMATTA  
JÄTTÄMINEN VOI JOHTAA VAKAVAAN  
LOUKKAANTUMISEEN TAI KUOLEMAAN.

**TÄRKEÄ** - LUE HUOLELLISESTI JA SÄILYTÄ  
MYÖHEMPÄÄ KÄYTTÖÄ VARTEN.



**VAROITUS** ILMAISEE VAARATILAN-  
TEEN, JOKA VOI JOHTAA KUOLEMAAN TAI  
VAKAVAAN LOUKKAANTUMISEEN, JOS SITÄ  
EI VÄLTETÄ.



**HUOMAUTUS** ILMAISEE LISÄTIETOJA,  
JOTKA OVAT HYÖDYLLISIÄ TUOTTEEN  
HÄIRIÖTTÖMÄN JA OPTIMAALISEN KÄYTÖN  
KANNALTA.

## TAKBOKS TIL TAKMONTERTE STATIVER

UNNLATELSE AV Å FØLGE PRODUSENTENS  
INSTRUKSJONER KAN FØRE TIL ALVORLIG  
PERSONSKADE ELLER DØD.

**VIKTIG** - LES NØYE OG OPPBEVAR FOR  
FREMtidig REFERANSE.



**ADVARSEL** INDIKERER EN FARLIG  
SITUASJON SOM, HVIS DEN IKKE UNNGÅS,  
KAN FØRE TIL DØD ELLER ALVORLIG  
SKADE.



**MERK** INDIKERER TILLEGGSINFORMAS-  
SJON SOM ER NYTTIG FOR PROBLEMFRI OG  
OPTIMAL BRUK AV PRODUKTET.

## ÞAKBOX FYRIR GRINDUR Á ÞAK

EF EKKI ER FARIÐ AÐ LEIÐBEININGUM  
FRAMLEIÐANDA GETUR ÞAÐ LEITT TIL AL-  
VARLEGRA MEIÐSLA EÐA DAUÐA.

**MIKILVÆGT** - LESIÐU VARLEGA OG  
HAFADU TIL FRAMTÍÐAR VIÐSLUNAR.



**VIÐVÖRUN** GEFUR TIL KYNNA HÆT-  
TULEGAR AÐSTÆÐUR SEM GÆTU LEITT  
TIL DAUÐA EÐA ALVARLEGRA MEIÐSLA EF  
EKKI ER VARIST.



**ATH** GEFUR TIL KYNNA VIÐBÓTARUP-  
PLÝSINGAR SEM ERU GAGNLEGAR FYRIR  
VANDRÆÐALAUSA OG BESTU NOTKUN  
VÖRUNNAR.

## KATUSELE PAIGALDATAV KATUSEBOKS

TOOTJA JUHISTE EIRAMINE VÕIB PÕHJUSTADA TÕSISEID VIGASTUSI VÕI SURMA.

**OLULINE** - LUGEGE HOOLIKALT LÄBI JA HOIDKE ALLES EDASPIDISEKS KASUTAMISEKS.



**HOIATUS** TÄHISTAB OHTLIKKU OLUKORDA, MILLE VÄLTIMATA JÄTMINE VÕIB PÕHJUSTADA SURMA VÕI RASKEID VIGASTUSI.



**MÄRKUS** TÄHISTAB LISATEAVET, MIS ON KASULIK TOOTE TÕRGETETA JA OPTIMAALSEKS KASUTAMISEKS.

## JUMTA KASTE UZ JUMTA UZSTĀDĀMIEM BAGĀŽNIEKIEM

RAŽOTĀJA NORĀDĪJUMU NEIEVĒROŠANA VAR IZRAISĪT NOPIETNAS TRAUMAS VAI NĀVI.

**SVARĪGI** - UZMANĪGI IZLASIET UN SAGLABĀJIET TURPMĀKAI LIETOŠANAI.



**BRĪDINĀJUMS** NORĀDA BĪSTAMU SITUĀCIJU, KAS, JA NO TĀS NETIEK NOVĒRSTA, VAR IZRAISĪT NĀVI VAI NOPIETNUS IEVAINOJUMUS.



**PIEZĪME** NORĀDA PAPILDU INFORMĀCIJU, KAS IR NODERĪGA, LAI BEZ PROBLĒMĀM UN OPTIMĀLI IZMANTOTU IZSTRĀDĀJUMU.

## ANT STOGO TVIRTINAMŲ SKERSINIŲ BAGAŽINĖS

JEI NESILAIKYSITE GAMINTOJO NURODYMŲ, GALITE SUNKIAI SUSIŽEISTI ARBA ŽŪTI.

**SVARBU** - ATIDŽIAI PERSKAITYKITE IR IŠSAUGOKITE ATEITYJE.



**ĮSPĖJIMAS** NURODO PAVOJINGĄ SITUACIJĄ, KURIOS NEIŠVENGUS GALI KILTI MIRTIS ARBA SUNKUS SUŽALOJIMAS.



**PASTABA** NURODO PAPILDOMĄ INFORMACIJĄ, KURI YRA NAUDINGA NORINT BE SUTRIKIMŲ IR OPTIMALIAI NAUDOTI GAMINĮ.

## ГРУЗОВОЙ БОКС НА КРЫШУ АВТОМОБИЛЯ

НЕСОБЛЮЖДЕНИЕ ИНСТРУКЦИЙ ПРОИЗВОДИТЕЛЯ МОЖЕТ ПРИВЕСТИ К СЕРЬЕЗНЫМ ТРАВМАМ ИЛИ СМЕРТИ.

**ВАЖНО** - ВНИМАТЕЛЬНО ПРОЧИТАЙТЕ И СОХРАНИТЕ ДЛЯ ДАЛЬНЕЙШЕГО ИСПОЛЬЗОВАНИЯ.



**ПРЕДУПРЕЖДЕНИЕ** УКАЗЫВАЕТ НА ОПАСНУЮ СИТУАЦИЮ, КОТОРАЯ, ЕСЛИ ЕЕ НЕ ПРЕДОТВРАТИТЬ, МОЖЕТ ПРИВЕСТИ К СМЕРТИ ИЛИ СЕРЬЕЗНЫМ ТРАВМАМ.





**ПРИМЕЧАНИЕ** УКАЗЫВАЕТ НА ДОПОЛНИТЕЛЬНУЮ ИНФОРМАЦИЮ, ПОЛЕЗНУЮ ДЛЯ БЕСПЕРЕБОЙНОГО И ОПТИМАЛЬНОГО ИСПОЛЬЗОВАНИЯ ИЗДЕЛИЯ.

ВАНТАЖНИЙ БОКС ДЛЯ БАГАЖНИКІВ ДЛЯ ДАХУ

НЕДОТРИМАННЯ ІНСТРУКЦІЙ ВИРОБНИКА МОЖЕ ПРИЗВЕСТИ ДО СЕРІОЗНИХ ТРАВМ АБО СМЕРТІ.

**ВАЖЛИВО** - УВАЖНО ПРОЧИТАЙТЕ ТА ЗБЕРЕЖІТЬ ДЛЯ ПОДАЛЬШОГО ВИКОРИСТАННЯ.

 **ПОПЕРЕДЖЕННЯ** ВКАЗУЄ НА НЕБЕЗПЕЧНУ СИТУАЦІЮ, ЯКА, ЯКЩО ЇЇ НЕ УНИКНУТИ, МОЖЕ ПРИЗВЕСТИ ДО СМЕРТІ АБО СЕРІОЗНИХ ТРАВМ.

 **ПРИМІТКА** ВКАЗУЄ НА ДОДАТКОВУ ІНФОРМАЦІЮ, КОРИСНУ ДЛЯ БЕЗПЕРЕБІЙНОГО ТА ОПТИМАЛЬНОГО ВИКОРИСТАННЯ ВИРОБУ.

BOX DACHOWY NA BAGAŻNIK MONTOWANY NA DACHU

NIERZESTRZEGANIE INSTRUKCJI PRODUCENTA MOŻE PROWADZIĆ DO POWAŻNYCH OBRAŻEŃ LUB ŚMIERCI.

**WAŻNE** - PRZECZYTAJ UWAŻNIE I ZACHOWAJ DO WYKORZYSTANIA W PRZYSZŁOŚCI.

 **OSTRZEŻENIE** WSKAZUJE NA NIEBEZPIECZNĄ SYTUACJĘ, KTÓRA, JEŚLI NIE ZOSTANIE UNIKNIĘTA, MOŻE SPOWODOWAĆ ŚMIERĆ LUB POWAŻNE OBRAŻENIA.

 **UWAGA** WSKAZUJE DODATKOWE INFORMACJE, KTÓRE SĄ PRZYDATNE DO BEZPROBLEMOWEGO I OPTIMALNEGO UŻYTKOWANIA PRODUKTU.

STŘEŠNÍ BOX PRO MONTÁŽ NA STŘECHU

NEDODRŽENÍ POKYŇŮ VÝROBCE MŮŽE VÉST K VÁŽNÉMU ZRANĚNÍ NEBO SMRTI.

**DŮLEŽITÉ** - PEČLIVĚ SI PŘEČTĚTE A USCHOVEJTE PRO BUDOUCÍ POUŽITÍ.

 **VAROVÁNÍ** OZNAČUJE NEBEZPEČNOU SITUACI, KTERÁ BY MOHLA VÉST K USMRČENÍ NEBO VÁŽNÉMU ZRANĚNÍ, POKUD SE JÍ NEZABRÁNÍ.

 **POZNÁMKA** OZNAČUJE DOPLŇUJÍCÍ INFORMACE, KTERÉ JSOU UŽITEČNÉ PRO BEZPROBLÉMOVÉ A OPTIMÁLNÍ POUŽÍVÁNÍ VÝROBKU.

TETŐRE SZERELHETŐ TETŐBOX

A GYÁRTÓ UTASÍTÁSAINAK BE NEM TARTÁSA SÚLYOS SÉRÜLÉSHEZ VAGY HALÁLHOZ VEZETHET.

**FONTOS** - OLVASSA EL FIGYELMESEN, ÉS ŐRIZZE MEG A KÉSŐBBI HASZNÁLATRA.

 **FIGYELMEZTETÉS** OLYAN VESZÉLYES HELYZETET JELEZ, AMELY, HA NEM KERÜLJÜK EL, HALÁLHOZ VAGY SÚLYOS SÉRÜLÉSHEZ VEZETHET.

 **MEGJEGYZÉS** A TERMÉK PROBLÉMA-MENTES ÉS OPTIMÁLIS HASZNÁLATÁHOZ HASZNOS KIEGÉSZÍTŐ INFORMÁCIÓKAT JELÖL.

## PORTBAGAJ DE ACOPERIȘ PENTRU CADRU DE BARE MONTATE PE ACOPERIȘ

NERESPECTAREA INSTRUCȚIUNILOR PRODUCĂTORULUI POATE DUCE LA VĂTĂMĂRI GRAVE SAU LA DECES.

**IMPORTANT** - CITIȚI CU ATENȚIE ȘI PĂSTRAȚI PENTRU REFERINȚE VIITOARE.



**AVERTISMENT** INDICĂ O SITUAȚIE PERICULOASĂ CARE, DACĂ NU ESTE EVITATĂ, AR PUTEA DUCE LA DECES SAU VĂTĂMĂRI GRAVE.

**i NOTĂ** INDICĂ INFORMAȚII SUPLEMENTARE CARE SUNT UTILE PENTRU UTILIZAREA OPTIMĂ ȘI FĂRĂ PROBLEME A PRODUSULUI.

## STREŠNÝ BOX NA STREŠNÉ NOSIČE

NEDODRŽANIE POKYNOV VÝROBCU MÔŽE VIESŤ K VÁŽNEMU ZRANENIU ALEBO SMRTI.

**DÔLEŽITÉ** - POZORNE SI PREČÍTAJTE A USCHOVAJTE PRE BUDÚCE POUŽITIE.



**VAROVANIE** OZNAČUJE NEBEZPEČNÚ SITUÁCIU, KTORÁ MÔŽE MAŤ ZA NÁSLEDOK SMŤ ALEBO VÁŽNE ZRANENIE, AK SA JEJ NEZABRÁNI.

**i POZNÁMKA** OZNAČUJE DODATOČNÉ INFORMÁCIE, KTORÉ SÚ UŽITOČNÉ PRE BEZPROBLÉMOVÉ A OPTIMÁLNE POUŽÍVANIE VÝROBKU.

## STREŠNI KOVČEK ZA STREŠNE PRTLJAŽNIKE

NEUPOŠTEVANJE NAVODIL PROIZVALCA LAHKO POVZROČI HUDE TELESNE POŠKODBE ALI SMRT.

**POMEMBNO** - POZORNO PREBERITE IN SHRANITE ZA PRIHODNJO UPORABO.



**OPOZORILO** OZNAČUJE NEVARNO SITUACIJO, KI LAHKO POVZROČI SMRT ALI HUDE TELESNE POŠKODBE, ČE SE JI NE IZOGNETE.

**i OPOMBA** OZNAČUJE DODATNE INFORMACIJE, KI SO KORISTNE ZA NEMOTENO IN OPTIMALNO UPORABO IZDELKA.

## КУТИЯ ЗА БАГАЖ ЗА РЕЛСИ, МОНТИРАНИ ВЪРХУ ПОКРИВА

НЕСПАЗВАНЕТО НА ИНСТРУКЦИИТЕ НА ПРОИЗВОДИТЕЛЯ МОЖЕ ДА ДОВЕДЕ ДО СЕРИОЗНО НАРАНЯВАНЕ ИЛИ СМЪРТ.

**ВАЖНО** - ПРОЧЕТЕТЕ ВНИМАТЕЛНО И ЗАПАЗЕТЕ ЗА БЪДЕЩИ СПРАВКИ.



**ПРЕДУПРЕЖДЕНИЕ** ПОКАЗВА ОПАСНА СИТУАЦИЯ, КОЯТО, АКО НЕ БЪДЕ ИЗБЕГНАТА, МОЖЕ ДА ДОВЕДЕ ДО СМЪРТ ИЛИ СЕРИОЗНО НАРАНЯВАНЕ.

**i ЗАБЕЛЕЖКА** ПОКАЗВА ДОПЪЛНИТЕЛНА ИНФОРМАЦИЯ, КОЯТО Е ПОЛЕЗНА ЗА БЕЗПРОБЛЕМНО И ОПТИМАЛНО ИЗПОЛЗВАНЕ НА ПРОДУКТА.

KROVNA KUTIJA ZA KROVNE NOSAČE NEPOŠTIVANJE UPUTA PROIZVOĐAČA MOŽE DOVESTI DO OZBILJNIH OZLJEDA ILI SMRTI.

**VAŽNO** - PAŽLJIVO PROČITAJTE I SAČUVAJTE ZA BUDUĆU REFERENCU.



**UPOZORENJE** OZNAČAVA OPASNU SITUACIJU KOJA, AKO SE NE IZBJEGNE, MOŽE DOVESTI DO SMRTI ILI OZBILJNE OZLJEDE.

**i NAPOMENA** OZNAČAVA DODATNE INFORMACIJE KOJE SU KORISNE ZA NEOMETANO I OPTIMALNO KORIŠTENJE PROIZVODA.

ΜΠΑΓΚΑΖΙΕΡΑ ΟΡΟΦΗΣ ΓΙΑ ΜΠΑΡΕΣ ΟΡΟΦΗΣ

Η ΜΗ ΣΥΜΜΟΡΦΩΣΗ ΜΕ ΤΙΣ ΟΔΗΓΙΕΣ ΤΟΥ ΚΑΤΑΣΚΕΥΑΣΤΗ ΜΠΟΡΕΙ ΝΑ ΟΔΗΓΗΣΕΙ ΣΕ ΣΟΒΑΡΟ ΤΡΑΥΜΑΤΙΣΜΟ Η ΘΑΝΑΤΟ.

**ΣΗΜΑΝΤΙΚΟ** - ΔΙΑΒΑΣΤΕ ΠΡΟΣΕΚΤΙΚΑ ΚΑΙ ΦΥΛΑΞΤΕ ΤΟ ΓΙΑ ΜΕΛΛΟΝΤΙΚΗ ΑΝΑΦΟΡΑ.



**ΠΡΟΕΙΔΟΠΟΙΗΣΗ** ΥΠΟΔΕΙΚΝΥΕΙ ΜΙΑ ΕΠΙΚΙΝΔΥΝΗ ΚΑΤΑΣΤΑΣΗ Η ΟΠΟΙΑ, ΕΑΝ ΔΕΝ ΑΠΟΦΕΥΧΘΕΙ, ΜΠΟΡΕΙ ΝΑ ΟΔΗΓΗΣΕΙ ΣΕ ΘΑΝΑΤΟ Η ΣΟΒΑΡΟ ΤΡΑΥΜΑΤΙΣΜΟ.

**i ΣΗΜΕΙΩΣΗ** ΥΠΟΔΕΙΚΝΥΕΙ ΠΡΟΣΘΕΤΕΣ ΠΛΗΡΟΦΟΡΙΕΣ ΠΟΥ ΕΙΝΑΙ ΧΡΗΣΙΜΕΣ ΓΙΑ ΤΗΝ ΑΠΡΟΣΚΟΠΤΗ ΚΑΙ ΒΕΛΤΙΣΤΗ ΧΡΗΣΗ ΤΟΥ ΠΡΟΪΟΝΤΟΣ.

ARAÇ ÜSTÜNE BAĞLANAN RAFLAR İÇİN TAVAN KUTUSU

ÜRETİCİNİN TALİMATLARINA UYULMAMASI CİDDİ YARALANMALARA VEYA ÖLÜME YOL AÇABİLİR.

**ÖNEMLİ** - DİKKATLİCE OKUYUN VE İLERİDE BAŞVURMAK ÜZERE SAKLAYIN.



**UYARI** ÖNLENMEDİĞİ TAKDİRDE ÖLÜM VEYA CİDDİ YARALANMAYLA SONUÇLANABİLECEK TEHLİKELİ BİR DURUMU BELİRTİR.



**NOT** ÜRÜNÜN SORUNSUZ VE OPTIMUM KULLANIMI İÇİN YARARLI OLAN EK BİLGİLERİ BELİRTİR.

KOTAK BUMBUNG UNTUK RAK YANG DIPASANG PADA BUMBUNG

IN-NUQQAS TA' KONFORMITÀ MAL-ISTRUZZJONIJIET TAL-MANIFATTUR JISTA' JWASSAL GĦAL KORRIMENT SERJU JEW MEWT.

**IMPORTANTI** - AQRA B'ATTENZJONI U ŻOMM GĦAL REFERENZA FUTUR.



**TWISSIJA** TINDIKA SITWAZZJONI PERIKOLUŻA LI, JEKK MA TIĠIX EVITATA, TISTA' TIRRIŻULTA F'MEWT JEW KORRIMENT SERJU.



**NOTA** TINDIKA INFORMAZZJONI ADDIZZJONALI LI HIJA UTLI GĦALL-UŻU OTTIMALI U MINGĦAJR PROBLEMI TAL-PRODOTT.



תא חפצים לגג הרכב

用于车顶架的车顶箱

אי ציות להוראות היצרן עלול להוביל לפגיעה חמורה או למוות.  
חשוב - קרא בעיון ושמור לעיון עתידי.

不遵守制造商的说明可能会导致严重伤害或死亡。  
重要 - 请仔细阅读并保留以备将来参考。

אזהרה 

אזהרה מציין מצב מסוכן שאם לא נמנע עלול לגרום למוות או לפגיעה חמורה.

 **警告** 表示危险情况, 如果不避免, 可能会导致死亡或重伤。

הערה 

הערה מציין מידע נוסף שימושי לשימוש אופטימלי ללא תקלות במוצר.

 **注意** 表示对产品的无故障和最佳使用有用附加信息。

صندوق سقف الحوامل المثبتة على السقف

車頂架專用車頂箱

قد يؤدي عدم الامتثال لتعليمات الشركة المصنعة إلى إصابة خطيرة أو الوفاة.

不遵守製造商的說明可能會導致嚴重傷害或死亡。  
重要 - 請仔細閱讀並保留以備將來參考。

هام - اقرأ بعناية واحتفظ به للرجوع إليه في المستقبل.

 **警告** 表示危险情况, 如果不避免, 可能会导致死亡或重伤。

تحذير يشير إلى موقف خطير ، إذا لم يتم تجنبه ، فقد يؤدي إلى الوفاة أو الإصابة الخطيرة.

 **注意** 表示對產品的無故障和最佳使用有用的附加信息。

ملاحظة تشير إلى معلومات إضافية مفيدة للاستخدام الخالي من المتاعب والأمثل للمنتج

## ルーフマウント型ラック用ルーフボックス

製造元の指示に従わない場合、重傷または死亡に至る可能性があります。

**重要** - 注意深く読み、将来の参考のために保管してください。



**警告** 回避しないと、死亡または重傷を負う可能性がある危険な状況を示します。

**i 注記** 製品を最適かつトラブルなく使用するために役立つ追加情報を示します。

## กล่องบนหลังคาสำหรับแร็คหลังคา

การไม่ปฏิบัติตามคำแนะนำของผู้ผลิตอาจนำไปสู่การบาดเจ็บสาหัสหรือเสียชีวิตได้

**สำคัญ** - อ่านอย่างระมัดระวังและเก็บไว้สำหรับการอ้างอิงในอนาคต.



**คำเตือน** ระบุสถานการณ์อันตรายซึ่งหากไม่หลีกเลี่ยง อาจส่งผลให้เสียชีวิตหรือบาดเจ็บสาหัสได้

**i หมายเหตุ** ระบุข้อมูลเพิ่มเติมที่เป็นประโยชน์สำหรับการใช้ผลิตภัณฑ์โดยปราศจากปัญหาและเหมาะสมที่สุด.

## 루프 장착 랙 루프 박스

제조업체의 지침을 따르지 않으면 심각한 부상이나 사망에 이를 수 있습니다.

**중요** - 주의 깊게 읽고 나중에 참조할 수 있도록 보관하십시오.



**경고** 피하지 않을 경우 사망이나 중상을 입을 수 있는 위험한 상황을 나타냅니다.

**i 주의** 제품을 문제 없이 최적으로 사용하는 데 유용한 추가 정보를 나타냅니다.

## KAXXA GHAL FUQ IS-SAQAF GHAL XTILLIERI MMUNTATI FUQ SAQA

KEGAGALAN MEMATUHI ARAHAN PENGLANG BOLEH MENGAKIBATKAN KECEDERAAN SERIUS ATAU KEMATIAN.

**PENTING** - BACA DENGAN TELITI DAN SIMPAN UNTUK RUJUKAN MASA HADAPAN.



**AMARAN** MENUNJUKKAN SITUASI BERBAHAYA YANG, JIKA TIDAK DIELAKKAN, BOLEH MENGAKIBATKAN KEMATIAN ATAU KECEDERAAN SERIUS.



**NOTA** MENUNJUKKAN MAKLUMAT TAMBAHAN YANG BERGUNA UNTUK PENGGUNAAN PRODUK YANG OPTIMUM DAN BEBAS MASALAH.

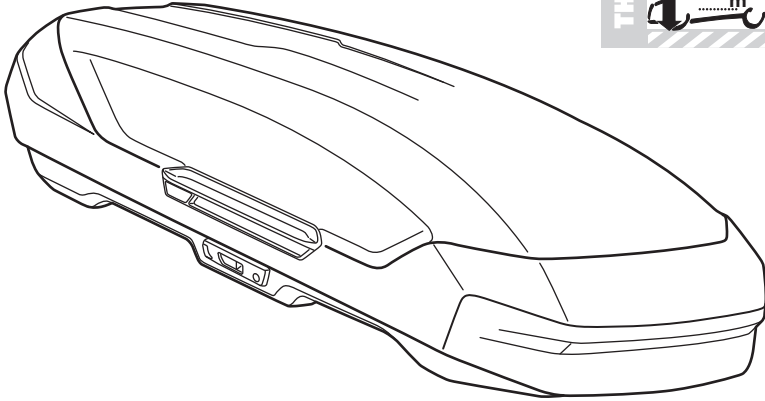

x1

x1

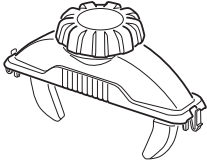

x4

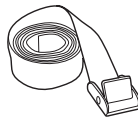

x3



x2

**i**



Your Key-Number

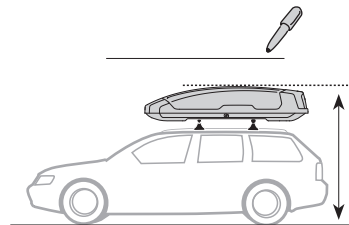

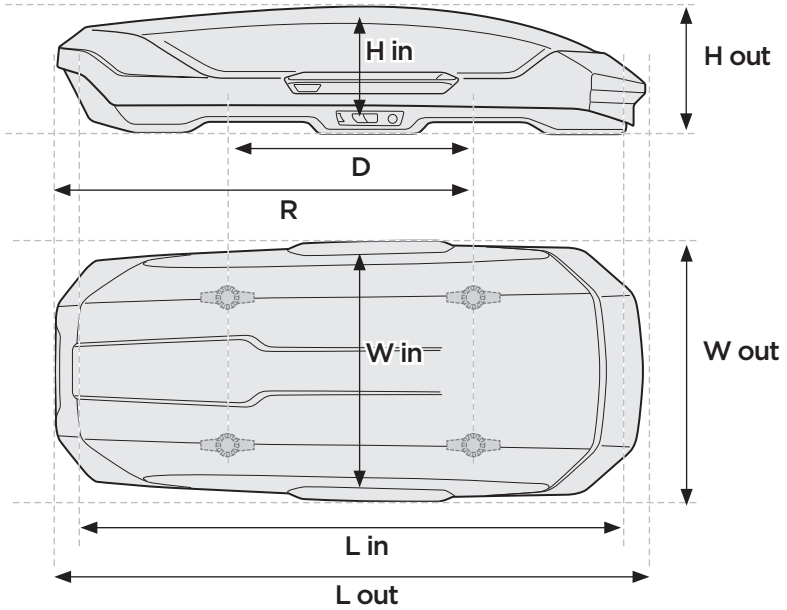

		D Min	D Max	L out	W out	H Out	R Min	L in	W in	H in
M	mm	555	930	1748	840	435	1147	1640	686	370
Sport	mm	555	930	1883	650	422	1244	1774	501	352
L	mm	555	930	1942	869	423	1304	1824	716	354
XL	mm	555	930	2151	890	428	1324	2024	736	350
XL Low	mm	555	930	2155	890	349	1324	2024	736	276
XXL	mm	555	930	2320	919	444	1391	2197	765	376
XXL Low	mm	555	930	2318	919	368	1391	2197	765	298

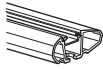

Thule WingBar Evo

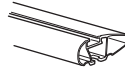

Thule WingBar

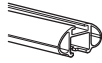

Thule AeroBar



Thule Squarebar



Thule SlideBar

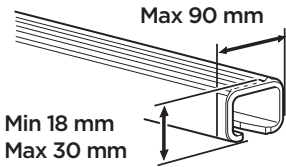

**Thule T-track Adapter**  
696600  
697600

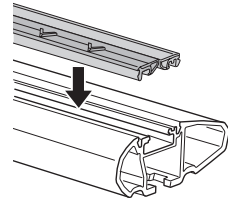
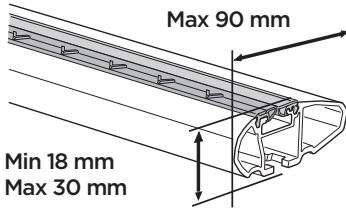

**Max 75 kg**

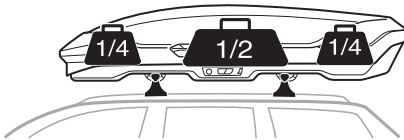

	Weight	Volume
M	17.3 kg	390 litre
Sport	14.8 kg	300 litre
L	19.8 kg	440 litre
XL	23.2 kg	490 litre
XL Low	23.2 kg	400 litre
XXL	25.2 kg	590 litre
XXL Low	25.2 kg	480 litre

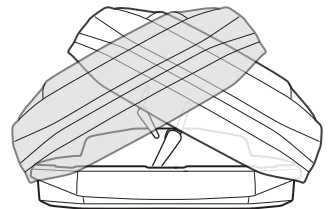

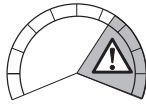
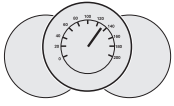

Max  
130 km/h

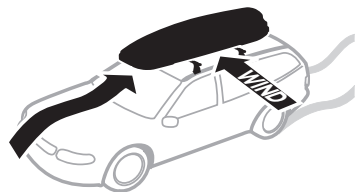
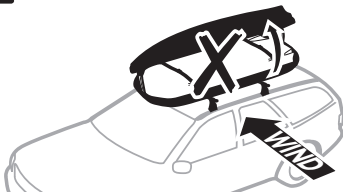
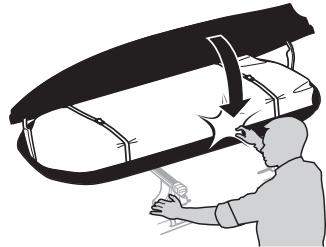
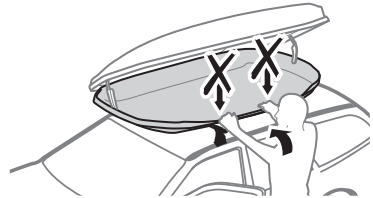
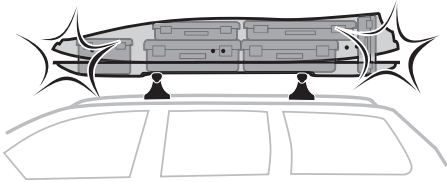
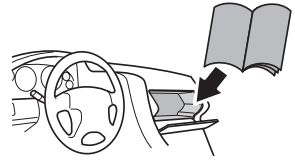

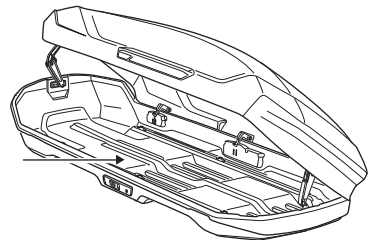
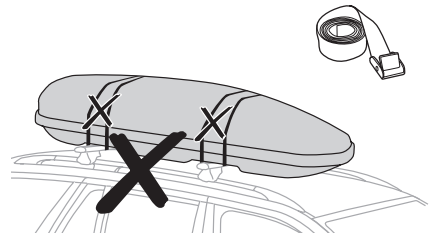
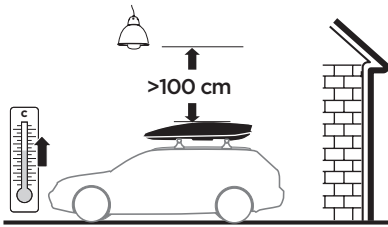
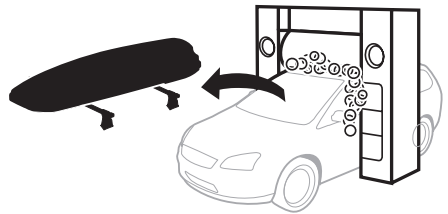
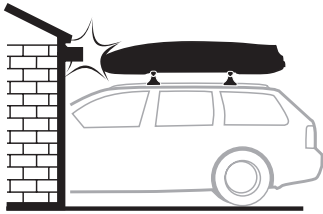
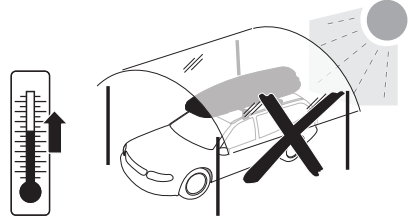
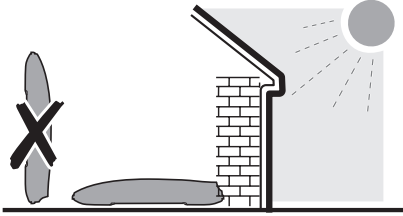

1

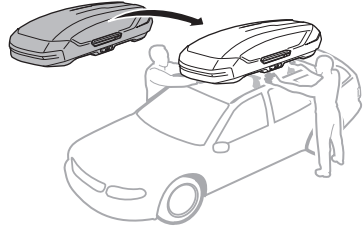

2

A

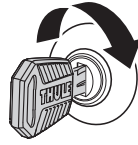
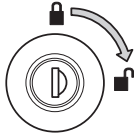

B

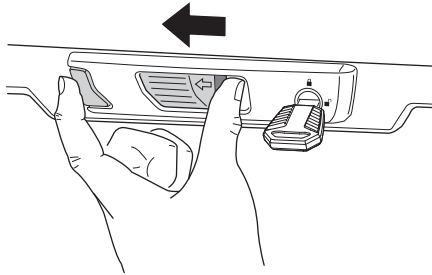

C

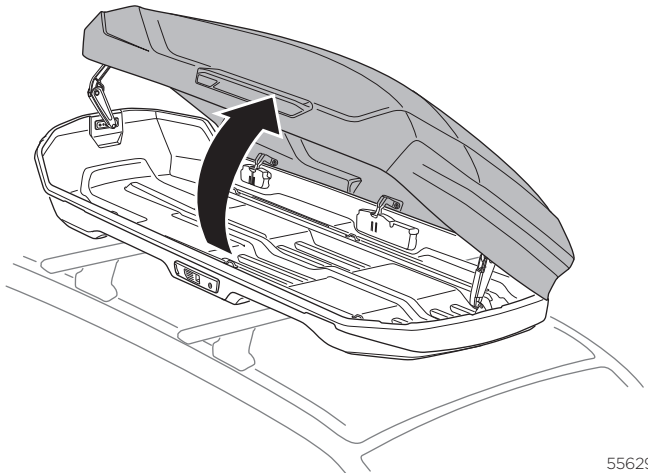



3

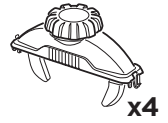

A

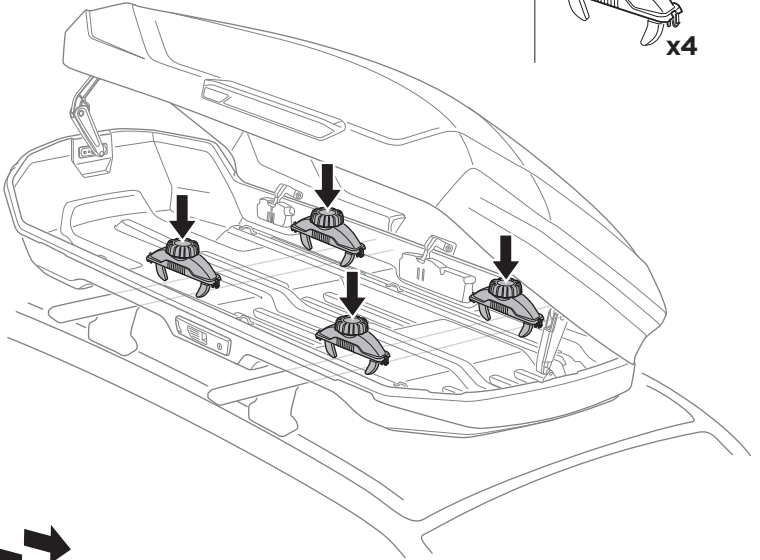
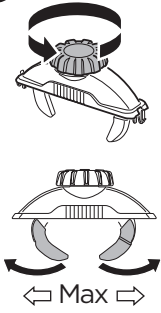

B

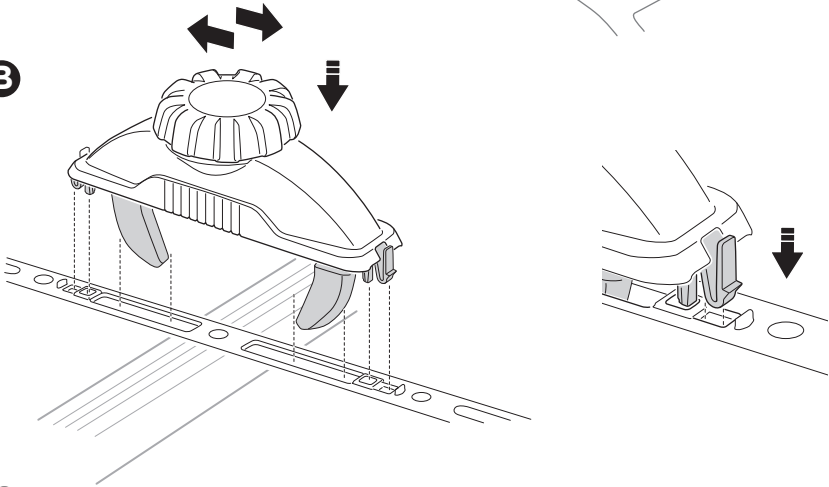

C

Click

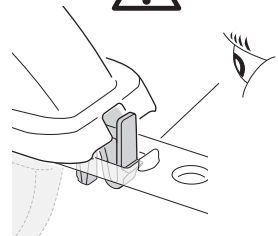
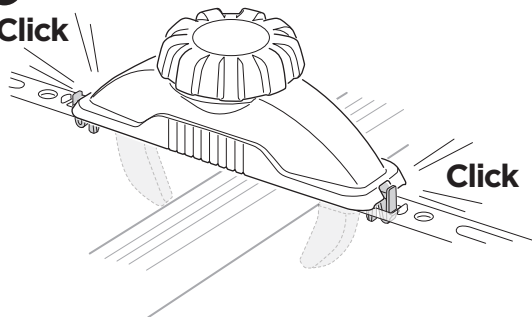

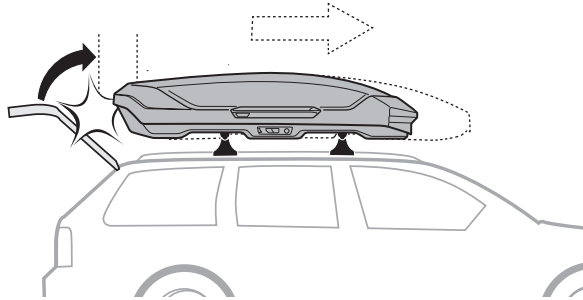

ok  
✓

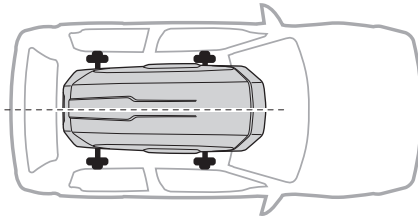

Not ok  
✗

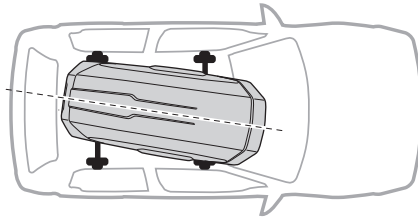

Not ok  
✗

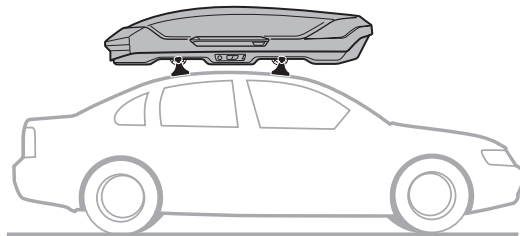

4

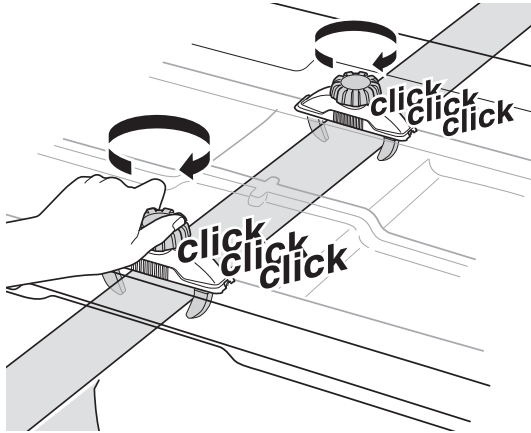
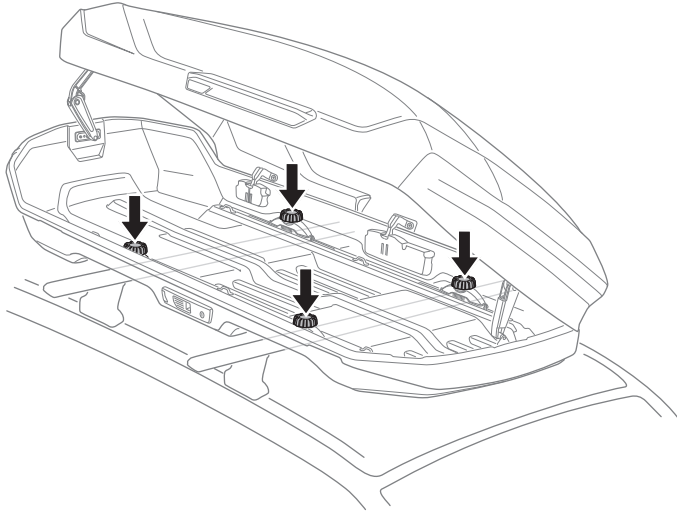

ok  
✓

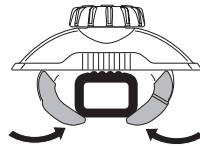
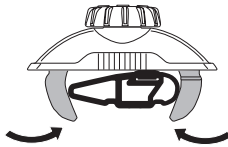

Not ok  
✗

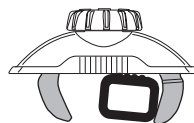
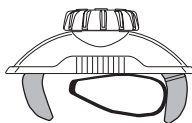

5

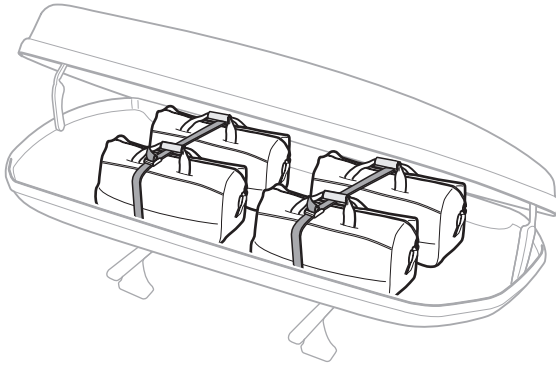
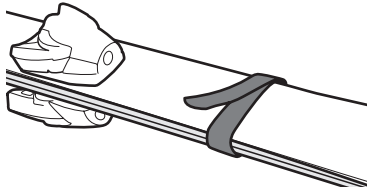
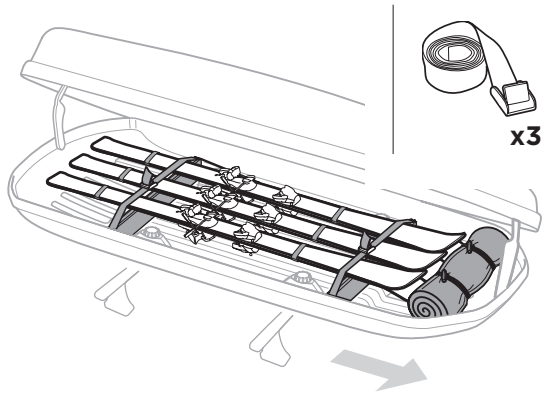

Not ok

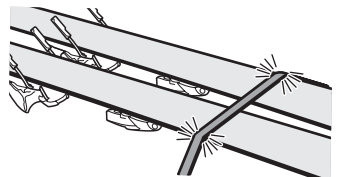
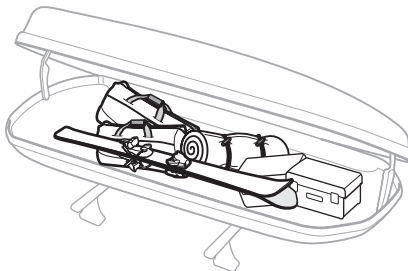

6

A

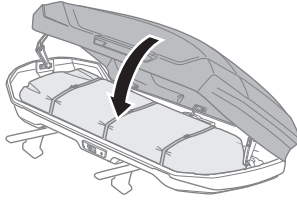

B

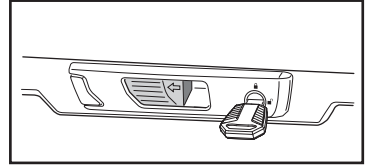
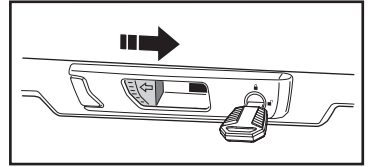
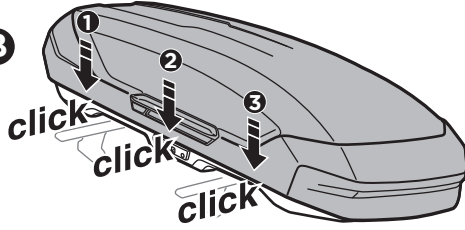

C

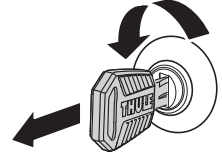
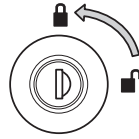
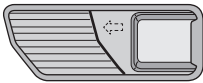
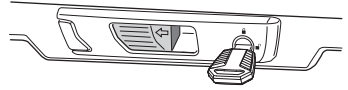

7

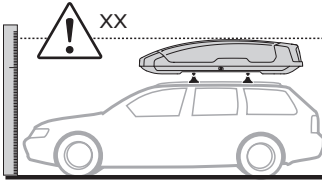

x1

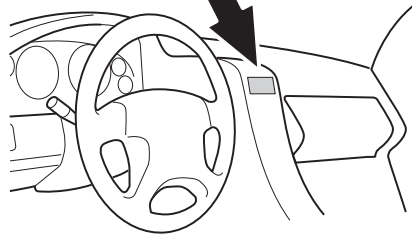

<b>EN</b> Accessories	<b>NO</b> Tilbehør	<b>CS</b> Doplněk	<b>MT</b> Accessorji
<b>FR</b> Accessoires	<b>FI</b> Lisävarusteet	<b>HU</b> Tartozékok	<b>HE</b> אביזרים
<b>ES</b> Accesorios	<b>IS</b> Aukabúnaður	<b>RO</b> Accesorii	<b>AR</b> ملحقات
<b>DE</b> Zubehör	<b>ET</b> Lisavarustus	<b>SK</b> Príslušenstvo	<b>ZH (CN)</b> 附件
<b>NL</b> Accessoires	<b>LV</b> Piederumi	<b>SL</b> Dodatki	<b>ZH (TW)</b> 配件
<b>PT</b> Acessórios	<b>LT</b> Priedai	<b>BG</b> Принадлежности	<b>JA</b> アクセサリー
<b>IT</b> Accessori	<b>RU</b> Аксессуары	<b>HR</b> Dodaci	<b>KO</b> 액세서리
<b>SV</b> Tillbehör	<b>UK</b> Аксесуари	<b>EL</b> Εξαρτήματα	<b>TH</b> อุปกรณ์เสริม
<b>DK</b> Tilbehør	<b>PL</b> Akcesoria	<b>TR</b> Aksesuarlar	<b>MS</b> Aksesori

### Thule lid pull straps 695900

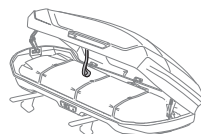
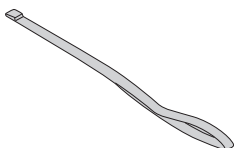

### Thule box light 695200

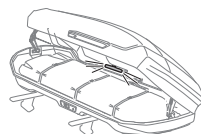
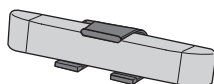

### Thule T-track Adapter

696600 ⇨ 24x30 mm

697600 ⇨ 20x27 mm

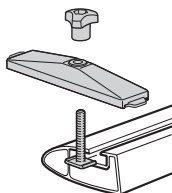

20-24 mm

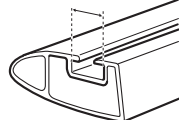

### Thule MultiLift 572004

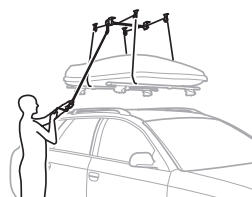
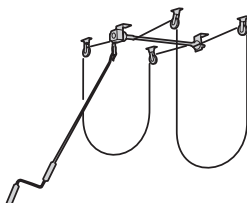

### Thule Box Ski Carrier Adapter

694500 ⇨ Sport

694700 ⇨ M

694800 ⇨ L/XL/XL Low

694900 ⇨ XXL/XXL Low

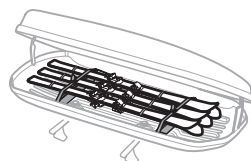
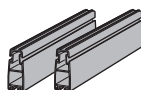

**Thule GoPack duffel set**  
800604



**Thule Comfort liner Motion 3**

- 649200 ➡ M
- 649600 ➡ Sport
- 649700 ➡ L
- 649800 ➡ XL/XL Low
- 649900 ➡ XXL/XXL Low



**Thule Box Lid Cover**

- 698100 ➡ M/L/Sport
- 698200 ➡ XL Low
- 698500 ➡ XL/XXL/XXL Low

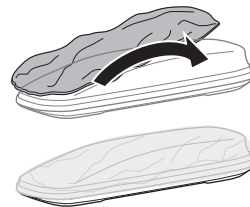

**Thule One-Key System**

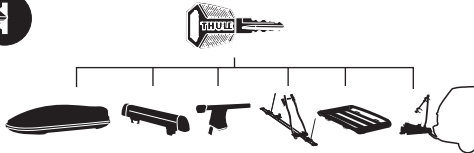

- 450400 🔋 (x4)
- 450600 🔋 (x6)
- 450800 🔋 (x8)
- 451200 🔋 (x12)
- 451600 🔋 (x16)

<p><b>1</b></p>	<p><b>2</b></p>	<p><b>3</b></p>
<p><b>4</b></p>	<p><b>5</b></p>	<p><b>6</b></p>
<p><b>7</b></p>	<p><b>8</b></p>	

